



AAKAT
INTERIOR DESIGN

+41 79 286 96 69 | contact@aatat.design | Rue Rothschild 50, 1202 CH – Genève, Suisse | [AAKAT.DESIGN](https://www.aakat.design)



AAKAT
INTERIOR DESIGN

Considérant que chaque projet est différent, il est important d'adapter le projet au regard du cahier des charges, calendrier et budget inhérent à chaque client.

Nous travaillons en collaboration avec des designers industriels et graphiques. En combinant ces disciplines, nous cherchons constamment comment ajouter valeurs et authenticité au projet que nous défendons.

Nos packs d'architecture d'intérieur sont des éléments clés en vue de présenter des projets de rénovation aux clients, et ce afin qu'ils puissent visualiser au mieux le résultat en amont des travaux.

Dans cette perspective, nous développons des dossiers de présentation à destination des professionnels : entreprise générales, agences immobilières, régies et architectes afin d'assurer une bonne communication entre les différents intervenants.

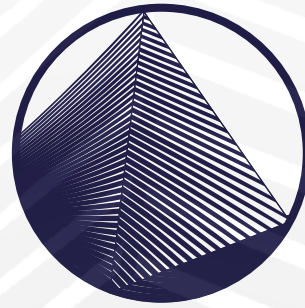

PACK
TRINITY

PROJET FINAL

Alexandra Ramos
ARCHITECTE D'INTERIEUR

PROJET FINAL

01 ARCHITECTURE INTERIEUR
DOSSIER DRESSING

02 CAHIER DES CHOIX
MATERIAUX & MEUBLES SANITAIRES

03 MEUBLES SUR-MESURE
SALLE DES BAINS MASTER

04 AMBIENCES FINALES
IMAGES 3D

Options :

-Prix d'image HD extra: 120.-chf

-Présentation client : facturé par heure. Tarif horaire : 150.-chf



AAKAT
INTERIOR DESIGN

01 ARCHITECTURE D'INTERIEUR

NOUVELLE DISTRIBUTION

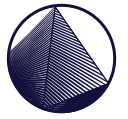

PACK
TRINITY

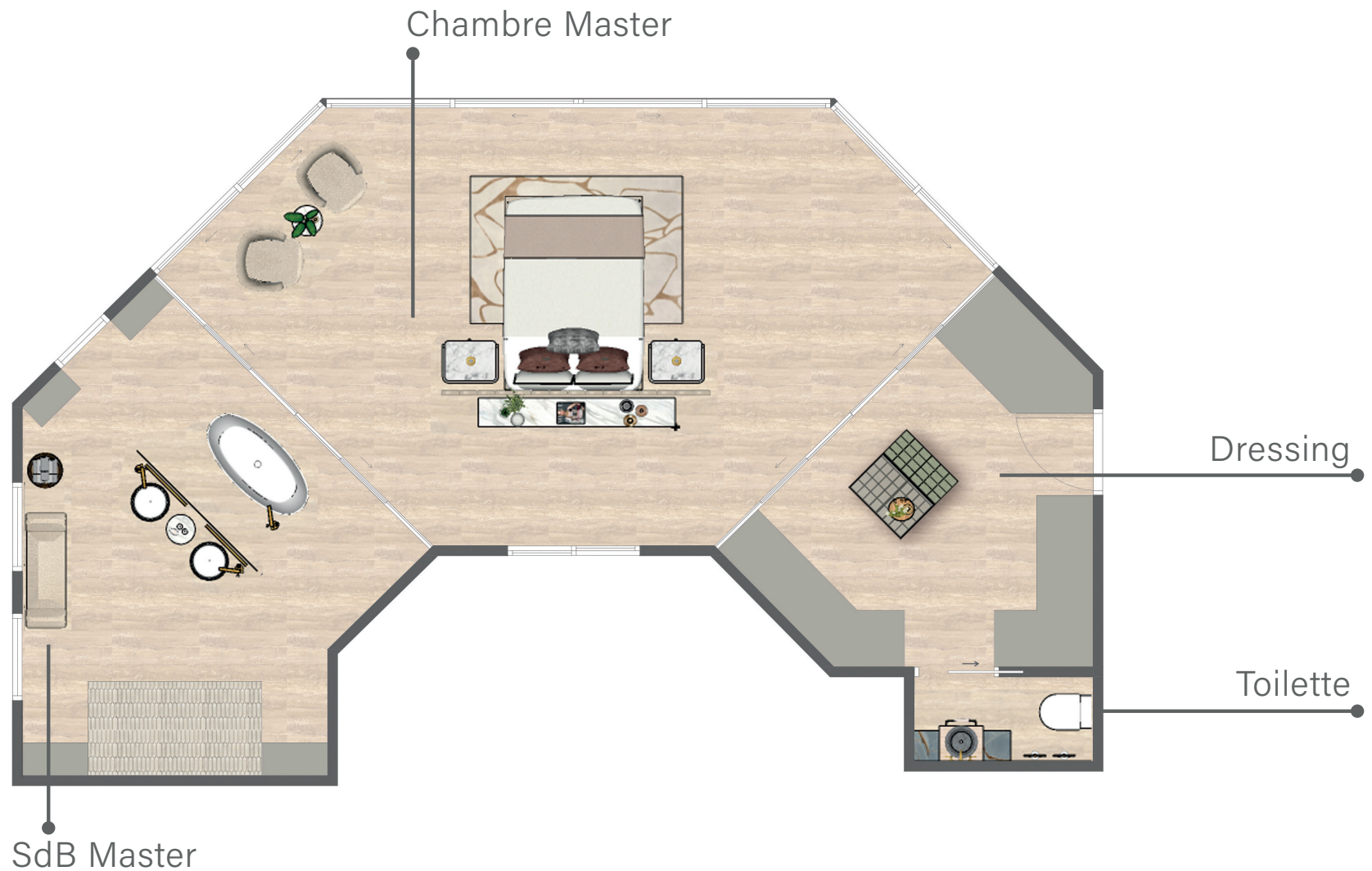



ARCHITECTURE D'INTERIEUR

DRESSING



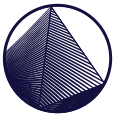

ARCHITECTURE D'INTERIEUR

DRESSING I PLAN DE MODULES

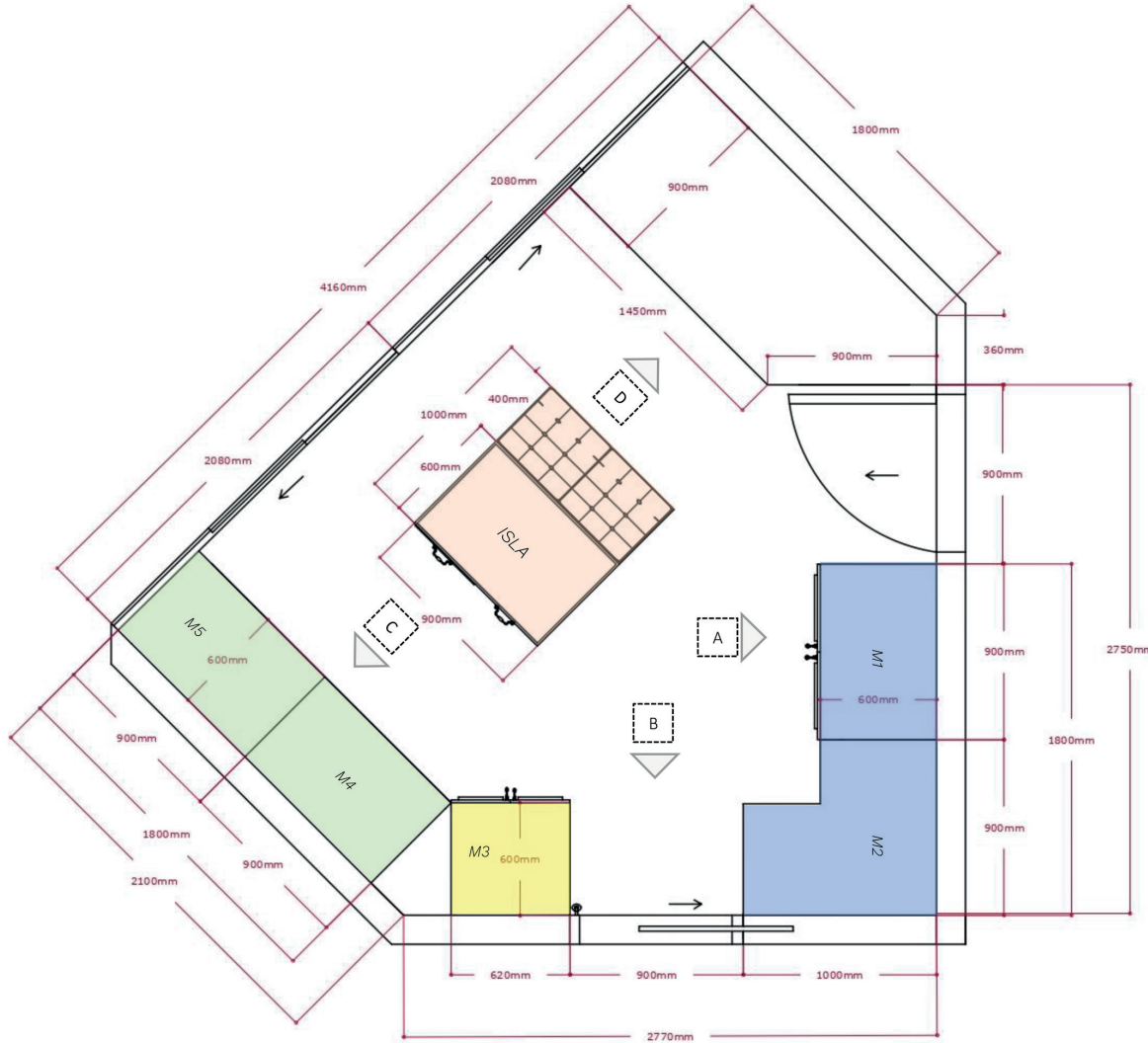

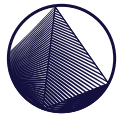

ARCHITECTURE D'INTERIEUR

DRESSING I PLAN & DETAIL

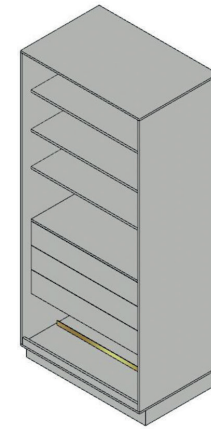
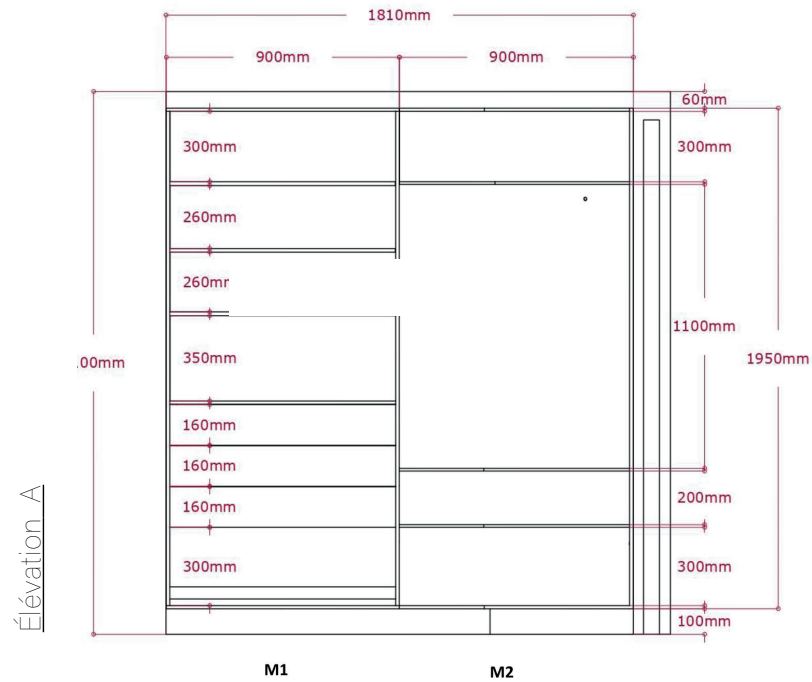
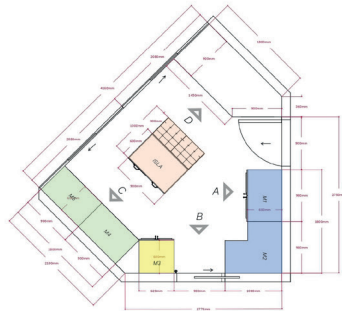

Détail M1
Vue isométrique

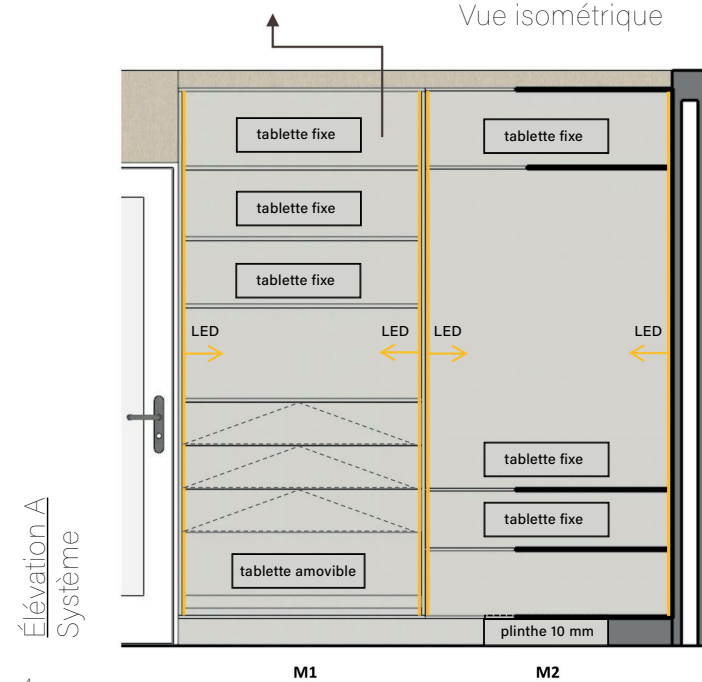

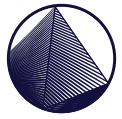

ARCHITECTURE D'INTERIEUR

DRESSING | PLAN & DETAIL

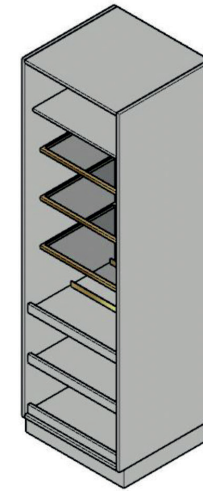
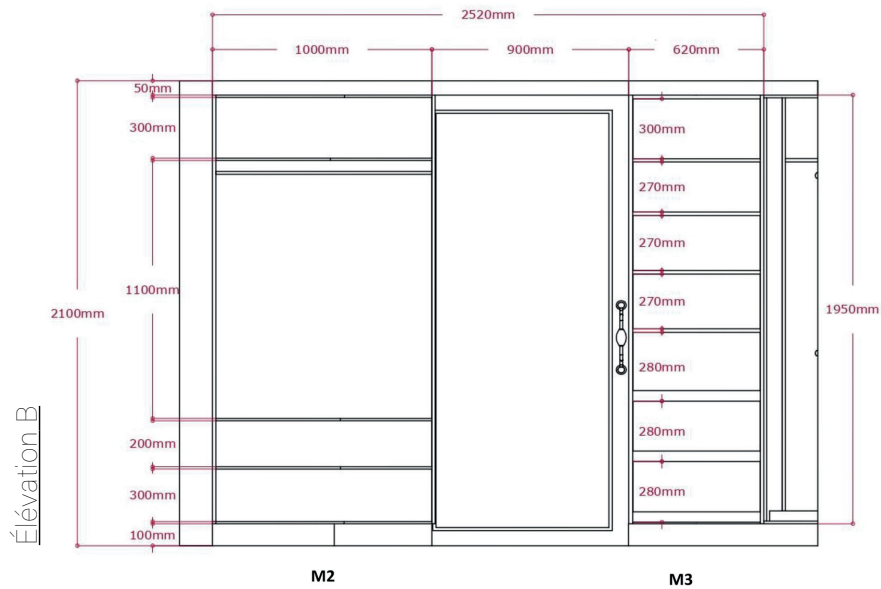
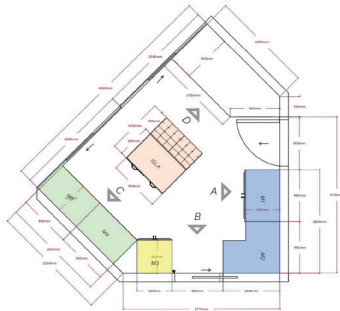

Détail M3
Vue isométrique

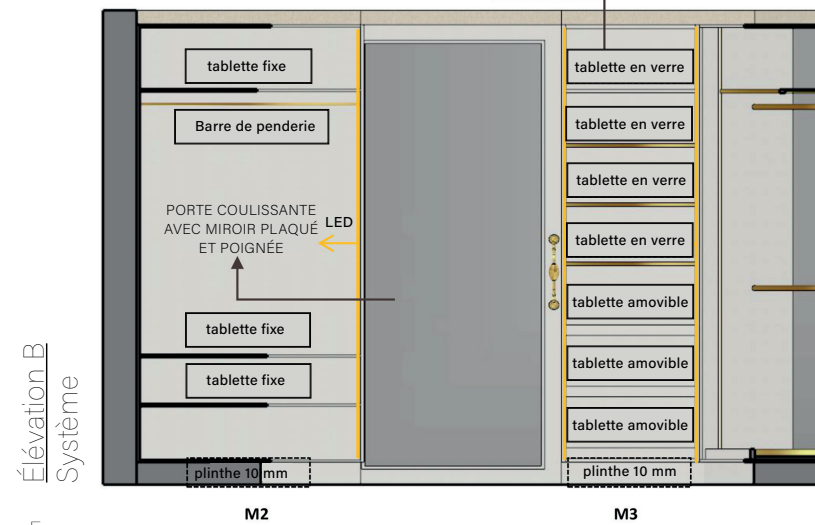

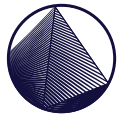

ARCHITECTURE D'INTERIEUR

PLAN DRESSING I MODULES

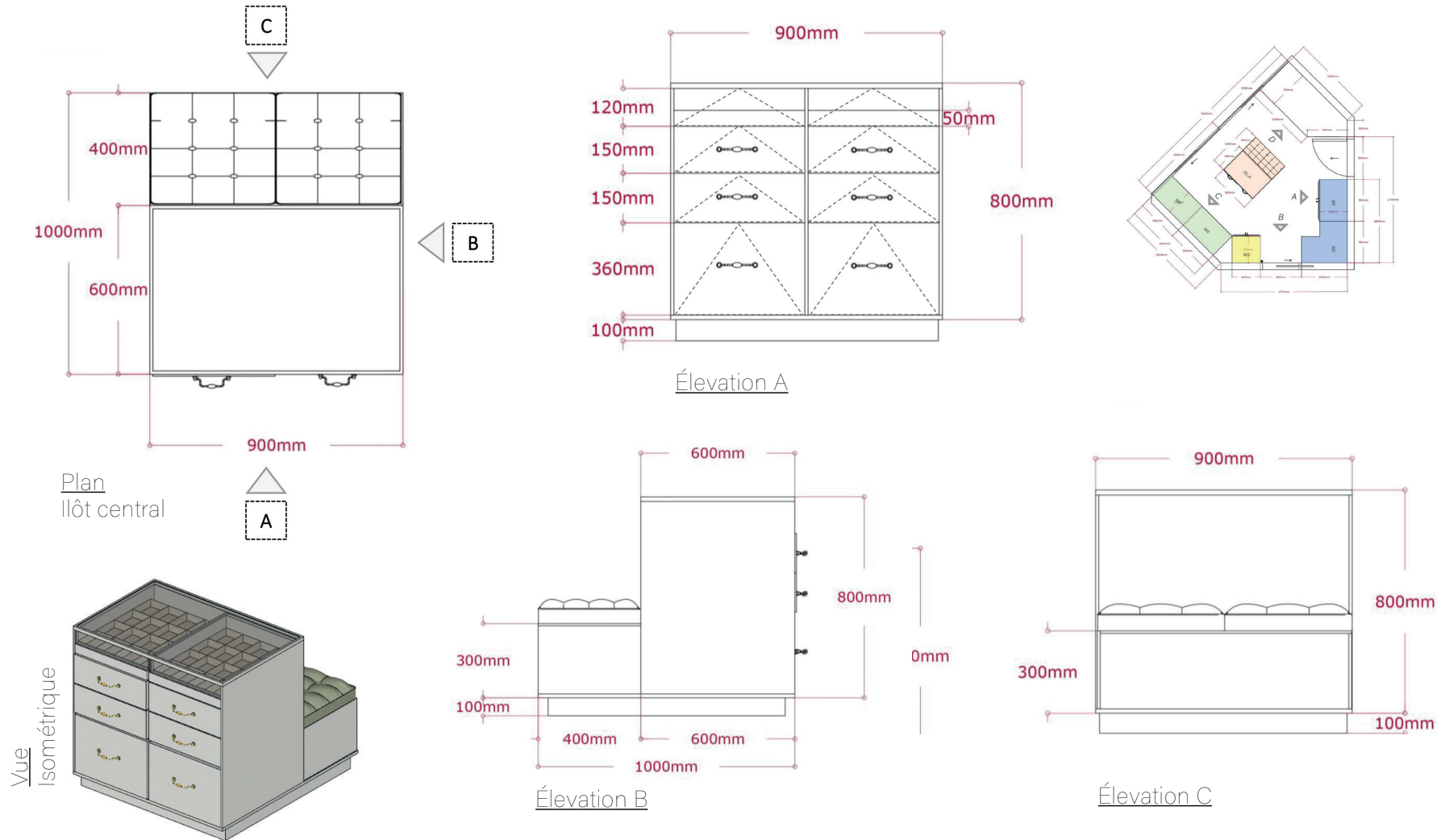

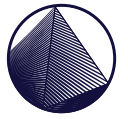

PACK
TRINITY

ARCHITECTURE D'INTERIEUR

DRESSING I PLAN & DETAIL

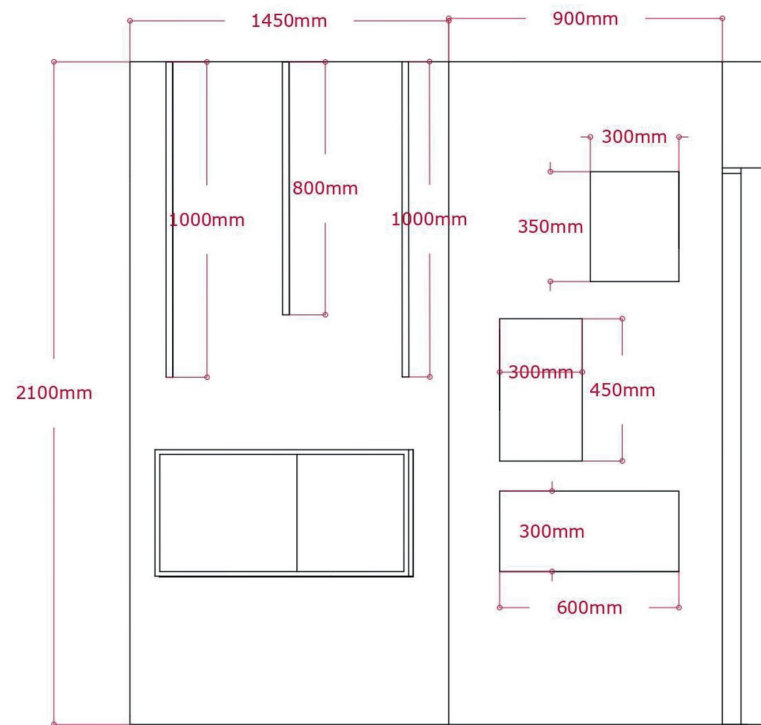

Élévation D

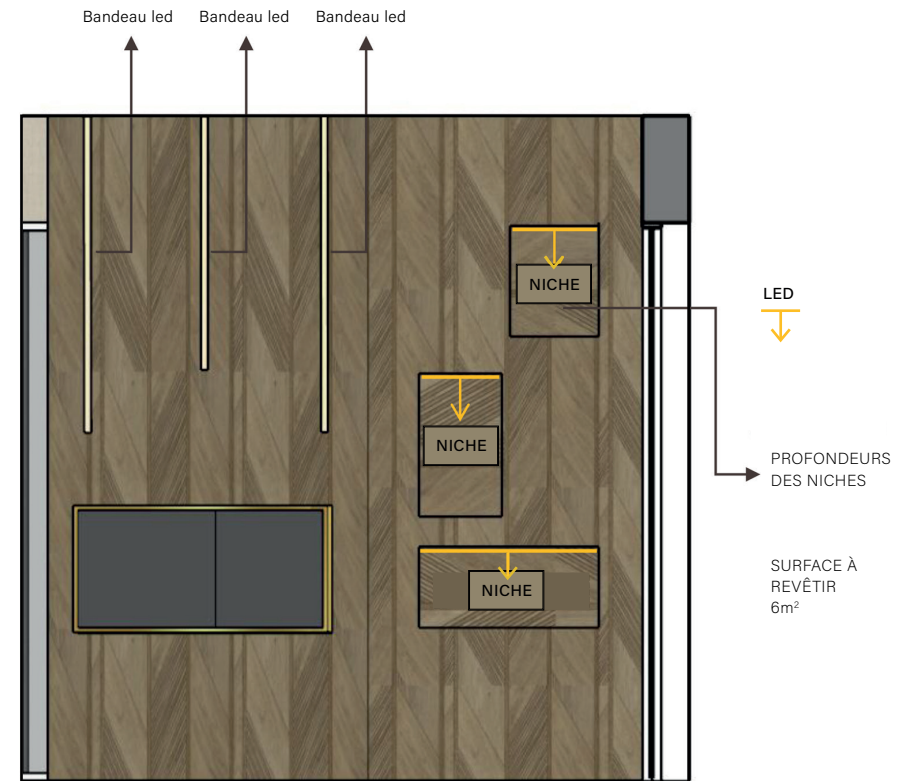

Élévation D
Vue avec textures

A moodboard collage featuring various textures and materials. The top left shows a circular pattern of fine lines. The top center is a layered stone texture. The top right is a close-up of a metallic corner. The middle left is a light-colored wall with a circular pattern. The middle right is a white jewelry box with an open drawer. The bottom left is a silver onyx wall texture. The bottom center is a wood-grain pattern with a chevron design. The bottom right is a white tufted ottoman.

Moodboard

Papier peint

DESERT
Masureel

Mobilier

BIANO LATTE
Brillant

Sol

RÊVE ALMOND
Minéral

Cheminée

ARROW 3D
Roble

Mur

SILVER ONYX
Brillant

ARCHITECTURE D'INTERIEUR

DRESSING
IMAGE 3D



PACK
TRINITY



ARCHITECTURE D'INTERIEUR

DRESSING | IMAGE 3D

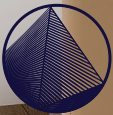

PACK
TRINITY



02 CAHIER DE CHOIX

PLAN MASTER BATHROOM

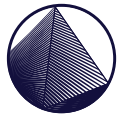

PACK
TRINITY

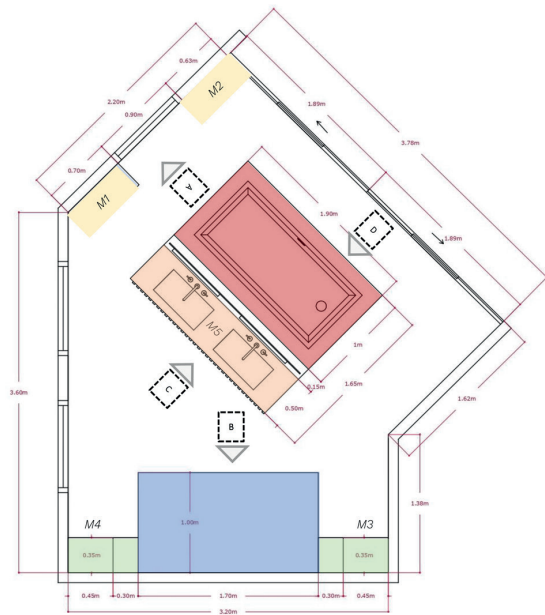

Modules
Salle des bains

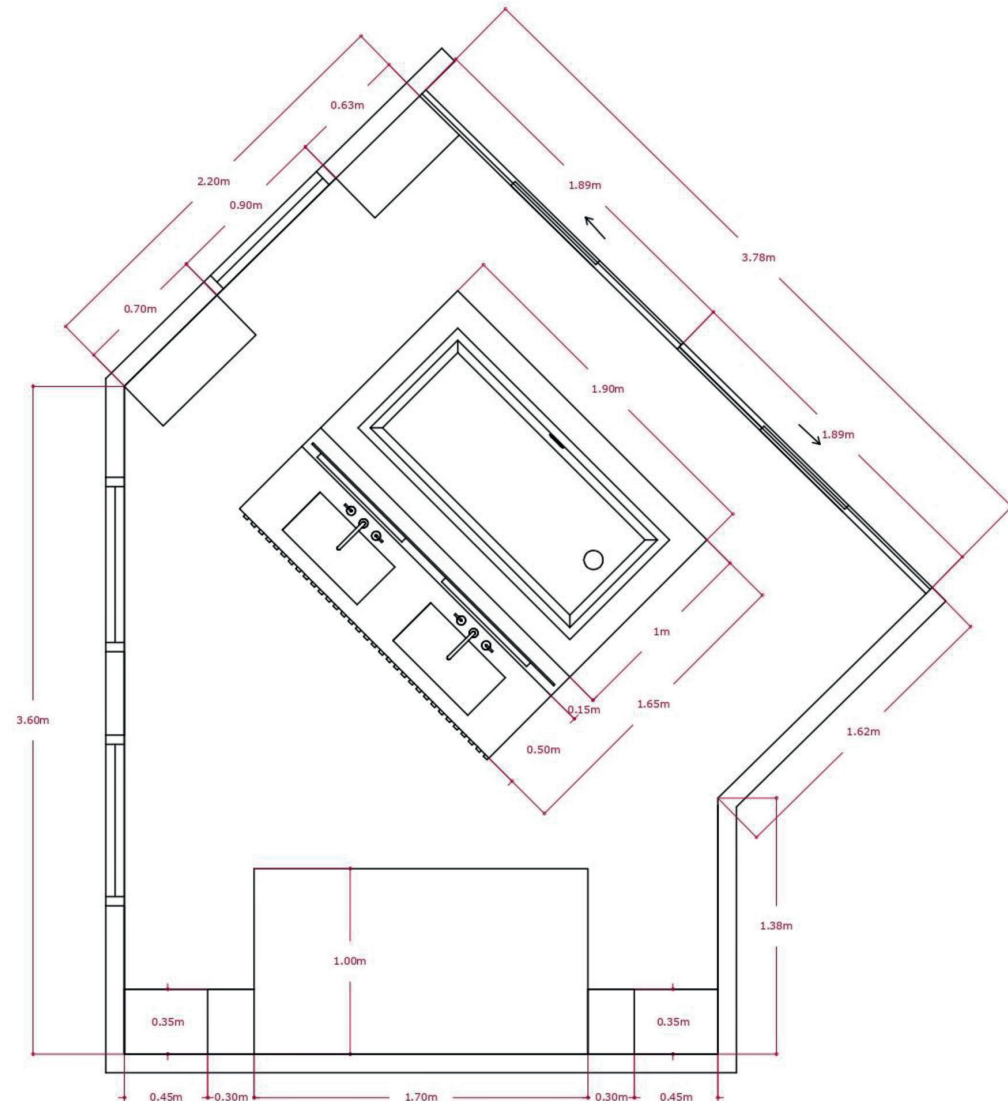

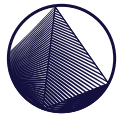

PACK
TRINITY

CAHIER DE CHOIX

MASTER BATHROOM

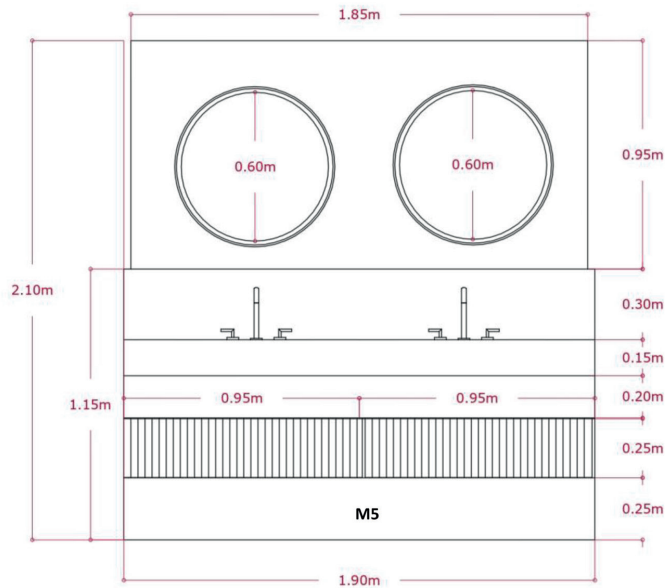

Élévation C

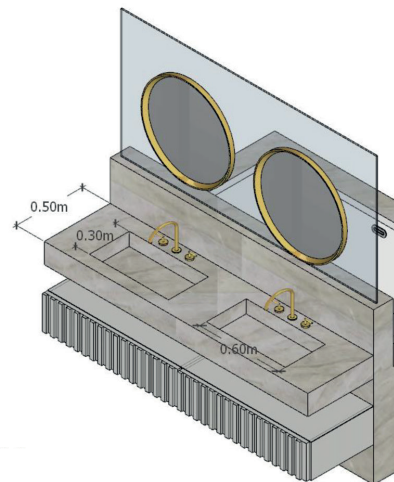

Élévation C
Détail M5

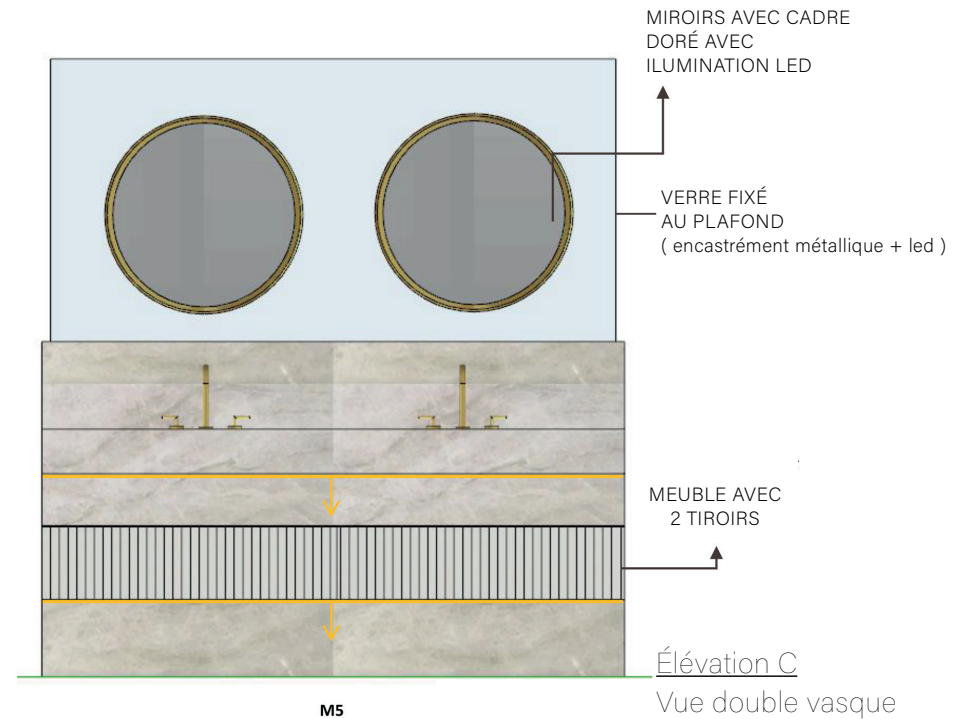
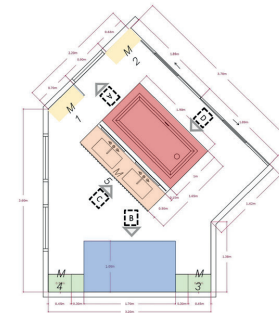

M5

Murs
GASA TOPO
Effet pailleté

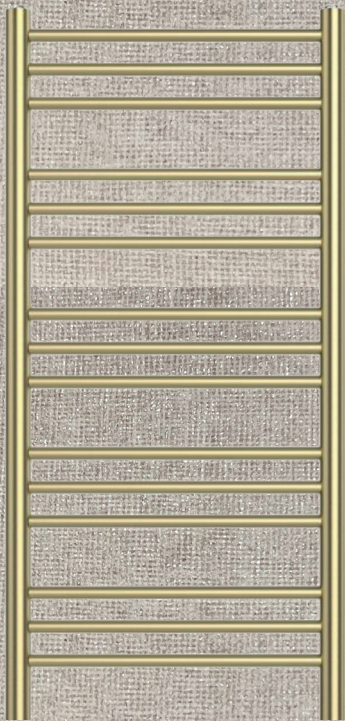

Moodboard



Mobilier
BIANO LATTE
Brillant



Baignoire
RÊVE BLUE
Effet Minéral

Mur décor
ONYX WHITE
Effet éclairé par led

Accessoires
GOLD
Brillant



Mur douche
CRYSTAL CREAM
Mosaïque

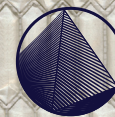

PACK
TRINITY

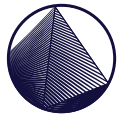

PACK
TRINITY

CAHIER DE CHOIX

MATERIAUX SDB MASTER



Sol
RÊVE ALMOND
Excentric luxe
FLORIM
60 m²



Mur Douche
CRYSTAL CREAM
MOSAIC
PORCELANOSA
6 m² / 11 pièces



Vasque & Baignoire
RÊVE BLUE
Excentric luxe
FLORIM
8 m²



Mur Déco
SILVER ONYX
Excentric luxe
FLORIM
9 m²



Murs SdB
GASA TOPO
Antic Colonial
PORCELANOSA
17 m²



Socle baignoire
ALMOND
Slabs
TERZADIMENSIONE
7 m²

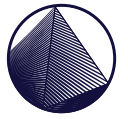

PACK
TRINITY

CAHIER DE CHOIX

ROBINETTERIE SDB MASTER

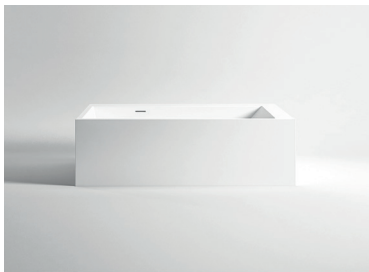

REXA
BAIGNOIRE
180x80x55 cm
UNICO DX



FANTINI
TÊTE DE DOUCHE
MATTE GOLD
ICONA DECO



FANTINI
MELANGEUR BAIGNOIRE
MATTE GOLD
ICONA DECO



FANTINI
MELANGEUR LAVABO
MATTE GOLD
ICONA DECO

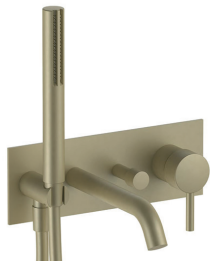

FANTINI
MITIGEUR DOUCHE
MATTE GOLD
ICONA DECO



PORCELANOSA
2X MIRROIRS
RETRO-ECLAIRE
ANTIC COLONIAL

03 MEUBLES SUR-MESURE

SALLE DES BAINS MASTER

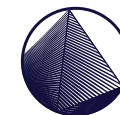

PACK
TRINITY

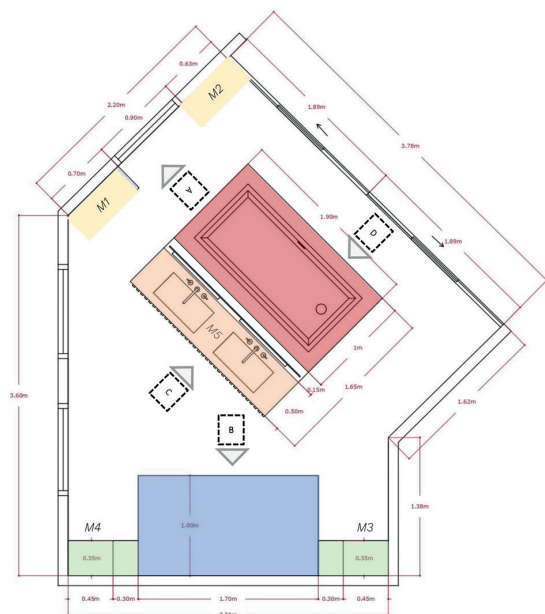

Modules

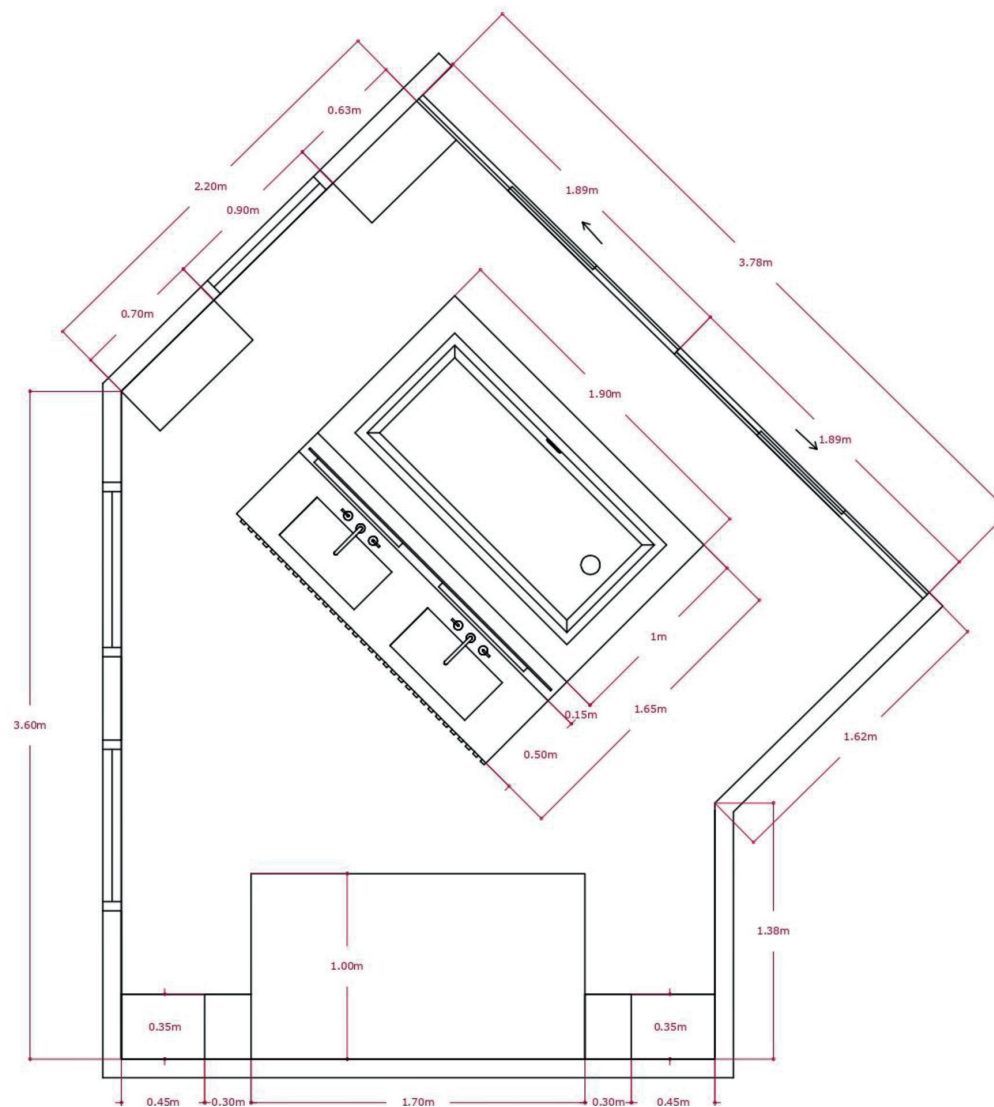

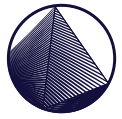

MEUBLES SUR-MESURE

CABINETS SALLE DES BAINS

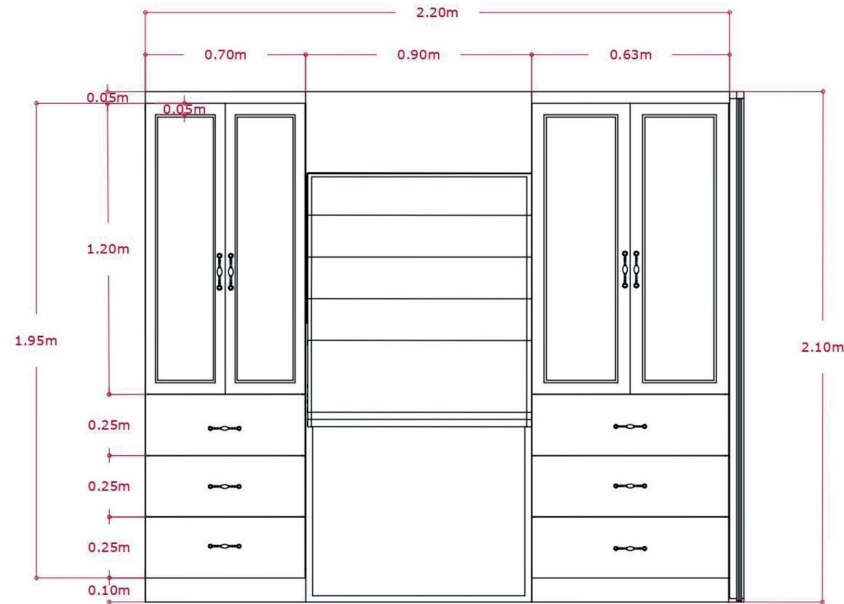

M1

M2

Élévation A

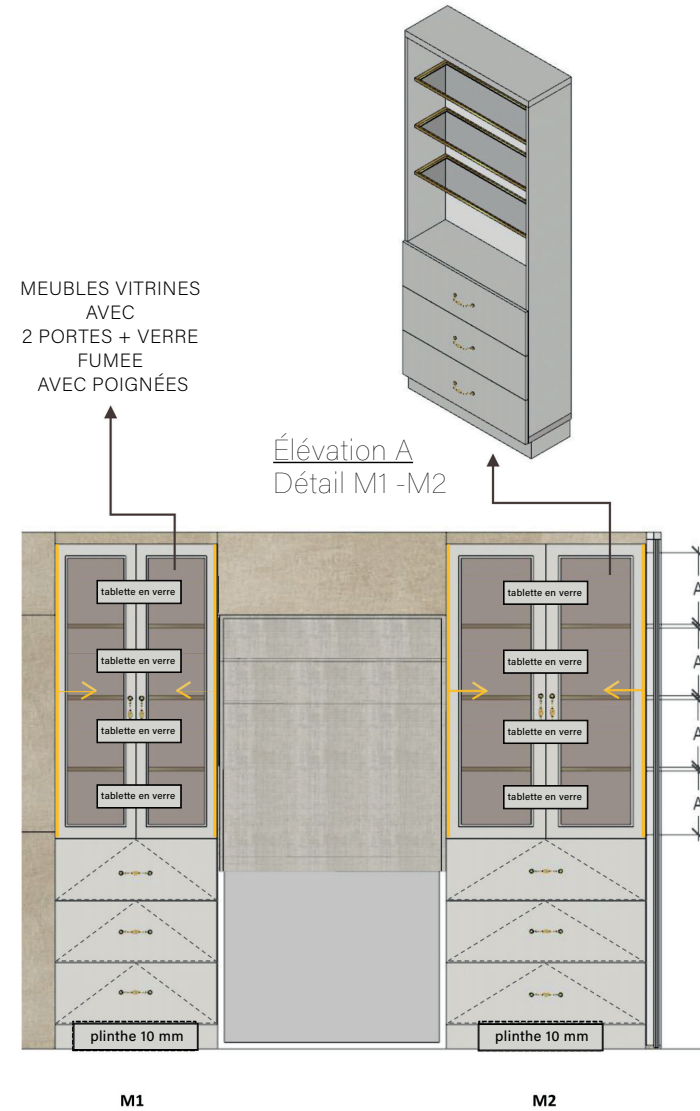
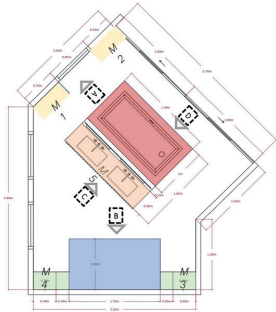

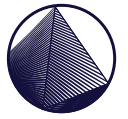

MEUBLES SUR-MESURE

SALLE DES BAINS MASTER

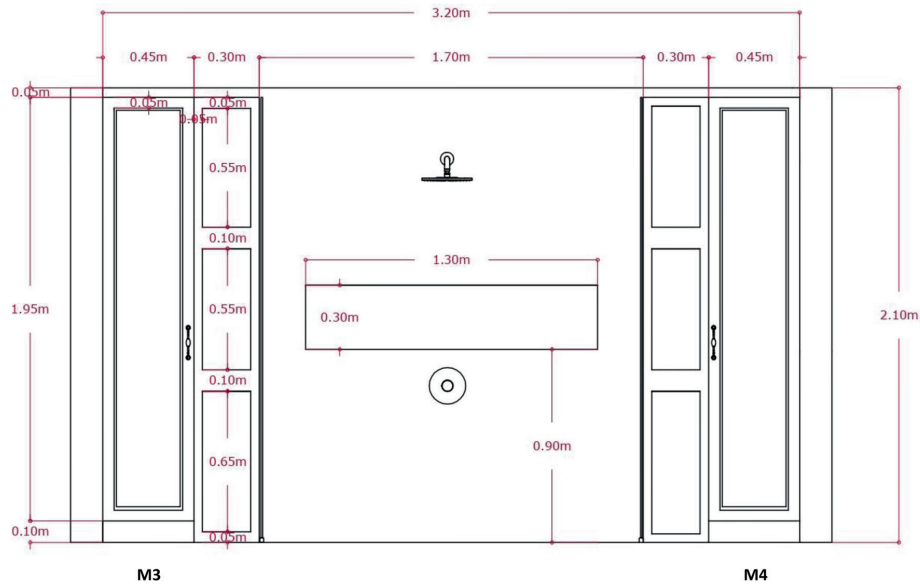

Élévation B

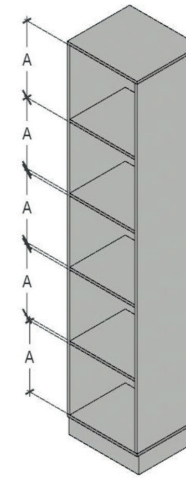

Élévation B
Détail M3 -M4

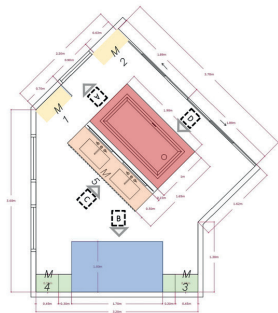

MEUBLE AVEC PORTE
MOULURÉE ET 4
ÉTAGÈRES FIXES

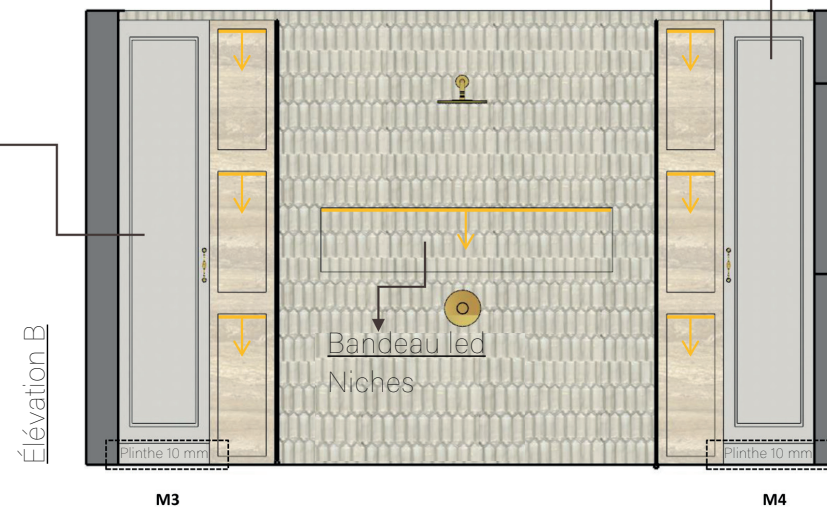

Élévation B

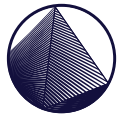

PACK
TRINITY

MEUBLES SUR-MESURE

CABINETS SALLE DES BAINS

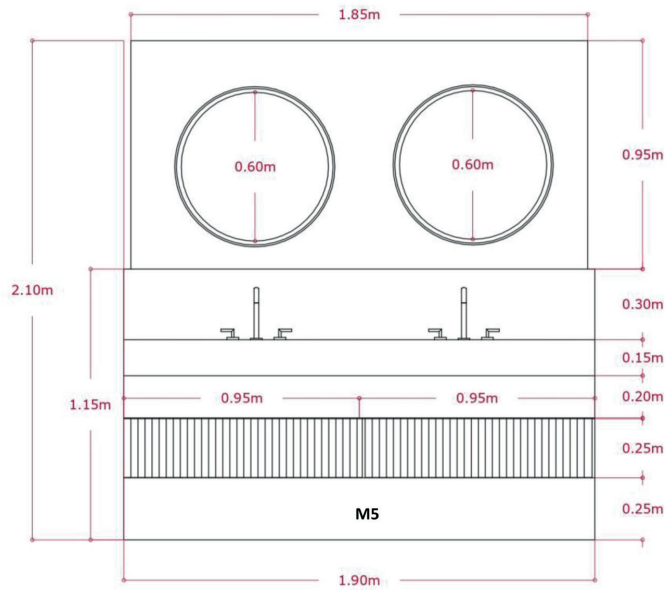

Élévation C

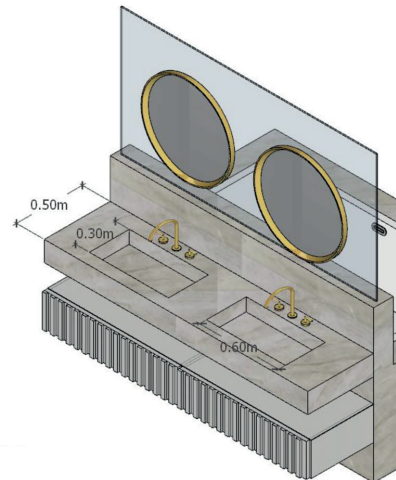

Élévation C
Détail M5

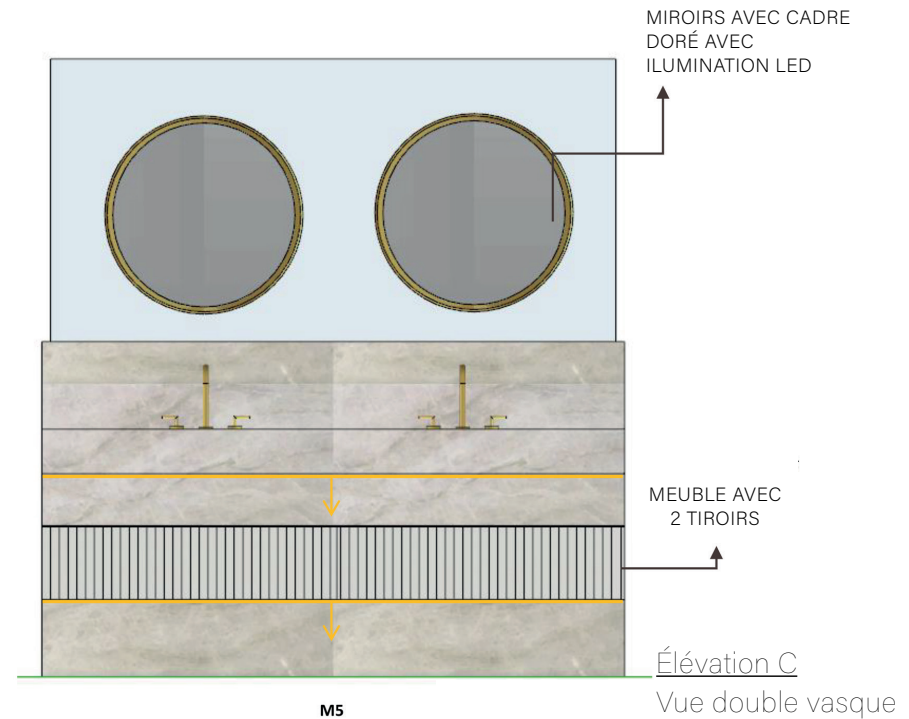
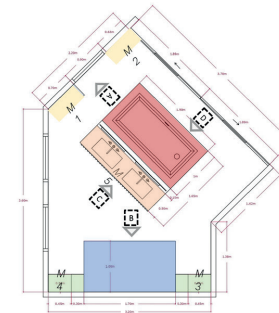

04 AMBIANCES FINALES

CHAMBRE MASTER

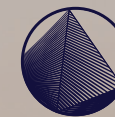

PACK
TRINITY



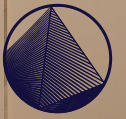

PACK
TRINITY

AMBIANCES FINALES

SDB MASTER



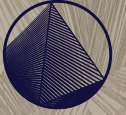

PACK
TRINITY

AMBIANCES FINALES

WC VISITEURS



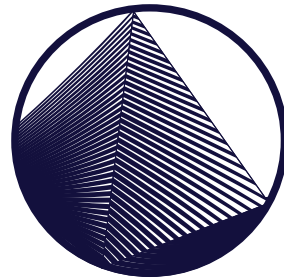

MERCI

PACK TRINITY
PROJET FINAL

Alexandra Ramos
ARCHITECTE D'INTERIEUR